

⚠ WARNING Before playing this game, read the Xbox 360® Instruction Manual and any peripheral manuals for important safety and health information. Keep all manuals for future reference. For replacement manuals, see www.xbox.com/support or call Xbox Customer Support.

Important Health Warning About Playing Video Games

Photosensitive seizures

A very small percentage of people may experience a seizure when exposed to certain visual images, including flashing lights or patterns that may appear in video games. Even people who have no history of seizures or epilepsy may have an undiagnosed condition that can cause these “photosensitive epileptic seizures” while watching video games.

These seizures may have a variety of symptoms, including lightheadedness, altered vision, eye or face twitching, jerking or shaking of arms or legs, disorientation, confusion, or momentary loss of awareness. Seizures may also cause loss of consciousness or convulsions that can lead to injury from falling down or striking nearby objects.

Immediately stop playing and consult a doctor if you experience any of these symptoms. Parents should watch for or ask their children about the above symptoms—children and teenagers are more likely than adults to experience these seizures. The risk of photosensitive epileptic seizures may be reduced by taking the following precautions: Sit farther from the screen; use a smaller screen; play in a well-lit room; do not play when you are drowsy or fatigued.

If you or any of your relatives have a history of seizures or epilepsy, consult a doctor before playing.

ESRB Game Ratings

The Entertainment Software Rating Board (ESRB) ratings are designed to provide consumers, especially parents, with concise, impartial guidance about the age-appropriateness and content of computer and video games. This information can help consumers make informed purchase decisions about which games they deem suitable for their children and families.

ESRB ratings have two equal parts:

- **Rating Symbols** suggest age appropriateness for the game. These symbols appear on the front of virtually every game box available for retail sale or rental in the United States and Canada.
- **Content Descriptors** indicate elements in a game that may have triggered a particular rating and/or may be of interest or concern. The descriptors appear on the back of the box next to the rating symbol.

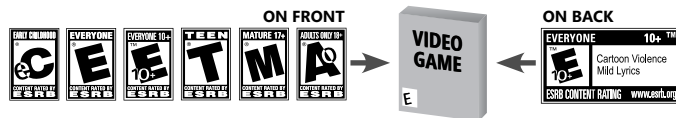

For more information, visit www.ESRB.org

CONTENTS

PROLOGUE.....	02
CHARACTERS	04
CONTROLS.....	06
STARTING THE GAME.....	08
RULES/SAVING YOUR GAME.....	10
COOPERATIVE PLAY	12
ACTIONS	14
COOPERATIVE ACTIONS.....	16
ITEM MENU/MAP/PAUSE MENU	18-19
ITEM MANAGEMENT	20
ABOUT XBOX LIVE	21
HINTS	22
VOICE ACTIONS	23
HISTORY	24

XBOX LIVE®

Play anyone and everyone, anytime, anywhere on Xbox LIVE®. Build your profile (your gamer card). Chat with your friends. Download content at Xbox LIVE® Marketplace. Send and receive voice and video messages. Get connected and join the revolution.

CONNECTING

Before you can use Xbox LIVE®, connect your Xbox 360® console to a high-speed Internet connection and sign up to become an Xbox LIVE® member. For more information about connecting, and to determine whether Xbox LIVE® is available in your region, go to www.xbox.com/live/countries.

FAMILY SETTINGS

These easy and flexible tools enable parents and caregivers to decide which games young game players can access based on the content rating. For more information, go to www.xbox.com/familysettings.

LANGUAGES THAT AREN'T SUPPORTED IN THE XBOX 360® DASHBOARD

If your game is available in a language that isn't supported in the Xbox 360® Dashboard, you must select a corresponding locale (region) in Console Settings to enable that language in the game. For more information, go to www.xbox.com

PROLOGUE

2009 AFRICA

A car moves across the ever stretching roads of the African continent. The vehicle stops somewhere within the Kijuju Autonomous Region, and a lone male figure steps out. His name is Chris Redfield.

As Chris looks around, a woman approaches him.



"Welcome to Africa. My name is Sheva Alomar."

Chris shakes her hand knowing that he will now have a partner on this mission.



Chris has lost many friends during countless missions. Sometimes he finds himself asking, is it all worth fighting for? It's not a question he knows the answer to. What he does know is that he has been given a mission, and he's going to carry it out.

"I'm on a personal mission, and I'm going to see it through."

RESIDENT EVIL 5



YOU READY, PARTNER?

CHRIS REDFIELD

Chris's knowledge, instinct, and attack power are unparalleled within the BSAA, and years of experience has given him the ability to wield a variety of weapons. Since Umbrella's downfall, he has fought several biological threats throughout the world, but with the hard fought victories has also come devastating tragedies.



MORE AND MORE I FIND MYSELF WONDERING IF IT'S ALL WORTH FIGHTING FOR.



THERE'S SOMETHING I HAVE TO DO.



TRUST ME, I MAY NOT BE AS BIG AS YOU
BUT I CAN CERTAINLY HOLD MY OWN..

SHEVA ALOMAR

A BSAA agent and an African native, Sheva joins as Chris's partner in his latest mission. Her skills in battle are formidable, and her agility is unparalleled. She is driven by her dark past to fight against the bioterrorism ravaging her homeland.



TELL ME ABOUT YOUR OLD PARTNER.

WE HAVETODOTHISFOROURFALLENBROTHERS.

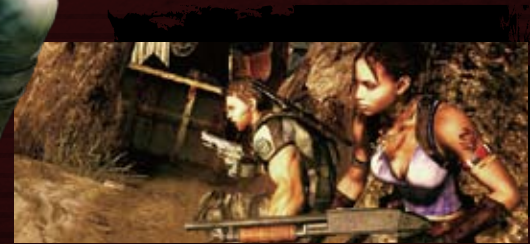

IT'S TIME TO MAKE A STAND!

CONTROLS



LB Button

Ready Knife
Hold the **LB** Button and press **RT** to perform a knife attack.

Left Stick

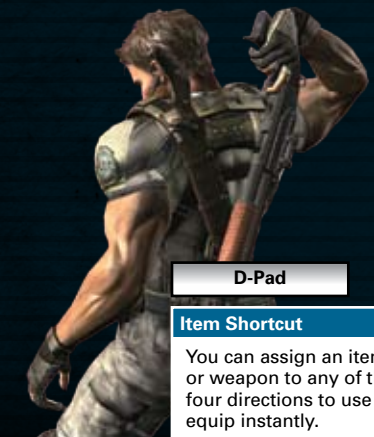
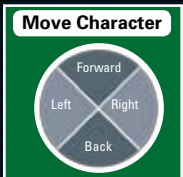

D-Pad

Item Shortcut
You can assign an item or weapon to any of the four directions to use or equip instantly.

RT Button

Ready Weapon
Hold the **RT** Button and press **RT** to perform an attack, or **A** to reload.



XBOX 360® CONTROLLER

*Controls shown are default settings. Controller settings can be changed at the "Options" screen.

Xbox Guide



RT Button

Fire Weapon/ Locate Partner
While the **RT** Button is held, press **RT** to fire. Otherwise, press **RT** to locate your partner.

RB Button

Display Map

Y Button
Display Item Menu.
(See P.18-19)

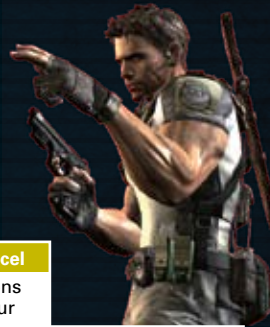

B Button

Co-op Action/Call/Cancel
Perform complex actions in conjunction with your partner. (See P.16-17)

Back Button

Skip Cinema

START Button

Open Pause Menu



X Button

Action
Perform a variety of context-sensitive actions. (See P.14-15)

Right Stick

Control the Camera

Targeting
Use this stick to aim your weapon while holding the **RT** or **LB** button.

A Button

Run/Quick Turn/Confirm
Left Stick **↑** + **A** Button: Run
Left Stick **↓** + **A** Button: 180-Degree Turn

STARTING THE GAME

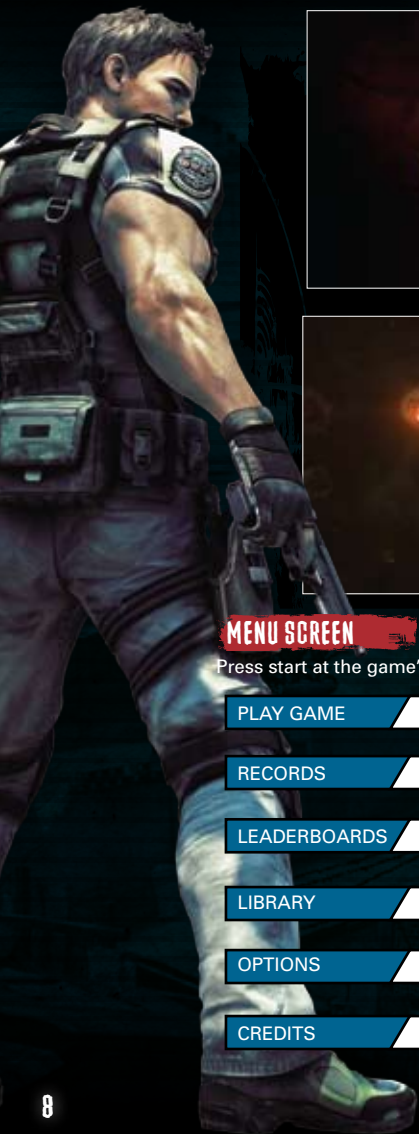

MENU SCREEN

Press start at the game's title screen to advance to the menu screen.

- PLAY GAME** / Choose a game mode.
- RECORDS** / View player statistics.
- LEADERBOARDS** / View the leaderboards.
- LIBRARY** / View documents, figurines, and cinemas.
- OPTIONS** / Change or confirm in-game options.
- CREDITS** / View Resident Evil 5 Credits.

GAME MODES

Choosing "Play Game" at the title screen advances you to the mode selection screen.

NEW GAME/CONTINUE

NEW GAME: Choose a difficulty level and begin a new game.
CONTINUE: Load saved data and continue playing from where you left off.

CHAPTER SELECT

Play through any chapter that you have already completed.

JOIN GAME

Play cooperatively online with another person. (See P.13)

ITEM MANAGEMENT

Choose, purchase, sell, or upgrade your items. (See P.20-21)

BONUS FEATURES

Exchange the points you have acquired in the game for bonus content.

SPECIAL SETTINGS

Access special options to further customize your game experience.

RULES/SAVING YOUR GAME

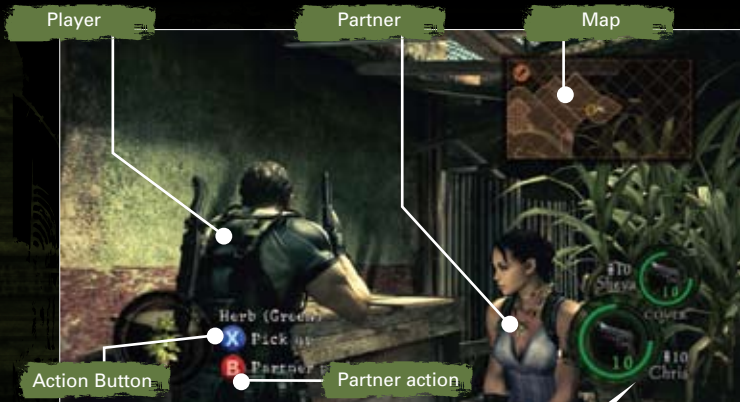

Health Gauge

Your character's health decreases as you take damage.

Equipment Icon

Displays your currently equipped item/weapon.

Remaining Ammo/Item

Displays equipped weapon's remaining ammo (before reload) or remaining equipped items.



Command Partner

Press the directional keys while holding the **B** Button to issue commands to your partner. "Cover" emphasizes defense while "Attack" emphasizes offense.

Reserve Ammo

Displays the reserve ammo for the currently equipped weapon.

GAME OVER

The game ends when one of the following occurs:

- Either the player or partner's dying gauge reaches zero.
- Both the player and partner are in the "DYING" state.
- You fail your assigned mission.

CONTINUING

If the game ends, you have the option of restarting from your last checkpoint. To continue, select "YES" at the continue screen.



SAVING

The game automatically saves when you begin a new chapter or choose to end your game from the pause menu.

Beginning a Chapter



Ending your Game



1100KB of data is required to save your game.

*Autoload data can only be loaded by pressing START at the menu select screen.

DYING STATUS

When a character takes too much damage he or she will enter the DYING state, causing his/her movement and actions to be restricted. As time passes or further damage is dealt, the DYING gauge will decrease; when it reaches zero, the game is over. Only your partner can rescue you from DYING. (see P.17)



COOPERATIVE PLAY

Two players can assume the roles of Chris and Sheva and enter into cooperative play."

OFFLINE COOPERATIVE PLAY

A second player can join in at any time during offline play. To join in the action, connect a second controller to the Xbox® 360 and press START. The game will pause and return to the Item Management screen. When you return to the game it will enter split-screen mode, and the second controller will control the partner character.

- * When you return to the game you will return to the previous checkpoint.
- * To end the Co-op play, please choose QUIT in the Pause menu.



WE'RE PARTNERS. TO THE END.

ONLINE CO-OP PLAY

Online Co-Op Play can take place in the following 2 ways.

1. You can connect to players all around the world using Xbox LIVE®. Please note that a broadband connection is required to use the Xbox LIVE® service. You can either host or join an online game.
2. You can use a System Link for Co-Op Play.

Two Xbox® 360 Consoles can be connected together for Co-Op Play. To prepare, connect two Xbox® 360 Consoles to two displays. For more information on how to connect with a system link, refer to the Xbox® 360 user manual.

After setting up the network environment, Co-Op Play will begin either as a host or as a guest.

After working with a partner to activate a mechanism, you may encounter a rare situation in which the game cannot advance any further after Co-Op Play is ended. If game play cannot continue, please open the Pause Menu and press the restart button.

HOSTING A GAME

Select the hosting option from the NETWORK screen when you select either NEW GAME or CHAPTER SELECT from the PLAY GAME menu. (You can play through the game while waiting for another player to join.)



NETWORK SELECTION

You can select the method of connecting to the network.

CO-OP SETTINGS

You can place restrictions on who will be allowed to join your game from the NETWORK screen.



After you have confirmed your settings, the game will begin as usual. A message will be displayed in the upper left corner of the screen when a player attempts to join. Follow onscreen instructions to permit or deny the request.

JOINING A GAME

Choose the JOIN GAME option in the MODE SELECT screen to join a game already in progress.



NETWORK SELECTION

You can select the method of connecting to the network.

QUICK MATCH

Search for a host without any specifications.

CUSTOM MATCH

Search for a host according to a set of customizable specifications.



You will then be able to choose which game to join. Confirm your selection with the A button. Follow onscreen instructions after having placed your request.

ACTIONS



Use your weapon's sight to target your foes.



AIM - FIRE

Hold down **R2** use the Right Stick to aim, then press the **R1** button to fire.

WEAPON RELOAD

Hold down **R2** and press the **A** button.

Pay attention to your ammunition. Ammo capacity varies by weapon.



KNIFE ATTACK!

Hold down **L3** to ready your knife, then press the **R1** button to attack.

This will allow you to attack with the knife. Use the Right Stick to change the direction of the attack.



QUICK TURN

Hold Down the Left Stick and press the **A** button.

Press the **A** button while moving back to execute a 180-degree turn.

RECOVERY

Equip a recovery item and press the **X** button.



Use a recovery item to restore your health.



Use a recovery item while standing by your partner to heal both of you.



Aim for their legs!

ACTION BUTTON

Get up close and press the **X** Button



UPPERCUT!!

Besides the attack actions, your character will also be able to perform various moves depending on his/her surroundings.

COOPERATIVE ACTIONS

Press the **B** Button during gameplay to perform a variety of cooperative actions. You can also give your partner an item or save him/her from an enemy's grasp.

CO-OP ACTIONS

When you can't move forward alone.

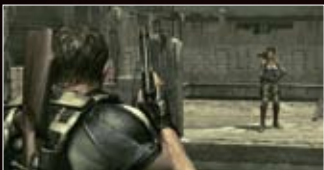

You made it!

Use the **B** Button to perform a co-op jump!



If you perform a co-op action when your partner is not nearby, you will assume the READY stance while you wait for your partner to arrive. You can cancel out of the READY stance by pressing the **X** button. You will not be able to move or perform standard actions until the co-op action is completed or cancelled.

TRADING ITEMS

You can pass an item or ammunition to your partner by equipping it and then pressing the **B** Button when nearby.



SAVING YOUR PARTNER FROM HELP STATUS



Your partner has been caught and needs your HELP.

Get close and press the **B** button.

Attack the enemy and save your partner!

If your partner is caught by an enemy, he/she will enter the HELP status. You can save your partner either by approaching him/her and pressing the **B** button, or by incapacitating the enemy with a weapon.



SAVING A DYING PARTNER

If your partner starts DYING, the screen will flash momentarily and his/her health gauge will display the word DYING. You can save your partner from certain doom by quickly approaching him/her and pressing the **B** Button.



IF YOU HAVE A RECOVERY ITEM
Press the **B** Button to heal



Your partner will be saved and regain some health.

IF YOU DO NOT HAVE A RECOVERY ITEM
Press the **B** Button to assist



Your partner will be saved but will not regain any health.

ITEM MENU/MAP/PAUSE MENU

Press the **Y** BUTTON during gameplay to open the Item Menu.

Your character will be unable to move while the Item Menu is open.



Closes the Item Menu (used for equipping items)

After highlighting an item press the **Y** button to equip the selected item and close the Item Menu.

The D-Pad acts as a quick shortcut button that you can use to equip four different items instantly. If you assign recovery items and/or powerful weapons to it, the dangers involved in switching equipment can be greatly reduced.



Use these to move the cursor.

D-PAD/ LEFT STICK



Opens and closes the Item Menu

Y BUTTON

Item Menu Control

Move item

Opens and closes your partner's Item Menu

After opening your partner's Item Menu with the **RB** Button, select an item in their Item Menu and press the **A** Button or the **X** Button to bring up the REQUEST command. Press **A** or **X** again to request the item.

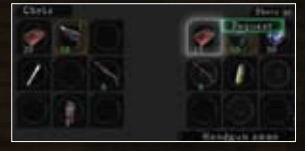

Once Menu Detail is open, use the **A** Button to perform the following actions.
Equip - Equip a weapon or item.
Use - Use a recovery item.
Give - Give an item to your partner.
Combine - Combine herbs or stack ammunition.
Discard - Discard an item.

X BUTTON
 Pressing the **X** Button will enable you to move an item. Move the cursor to the desired location and press the **X** Button again to move an item.

PAUSE MENU

Open the PAUSE MENU by pressing the START Button during gameplay.

- RESUME** Resume gameplay.
- RESTART** End your current game and restart from the last checkpoint.
- OPTIONS** Change various sound, control, and display options. Follow onscreen information concerning the different options.
- QUIT** End your current game and return to the Title Screen.

This game supports Dolby® Digital 5.1. In order to enjoy Dolby Digital 5.1 Surround Sound you must connect your Microsoft Xbox 360™ Console to a surround sound system that supports Dolby Digital using an optical digital cable, while using an Xbox 360 D Port HD AV Cable, Xbox 360 Component HD AV Cable, Xbox 360 VGA HA AV Cable or Xbox 360 S Video AV Cable. Then, you must go to the Xbox 360 Dashboard and select "System," then "System Settings," "Audio Settings," "Digital Output Settings" and finally "Dolby Digital 5.1."

MAP

Open the map by pressing the **RB** Button during gameplay.

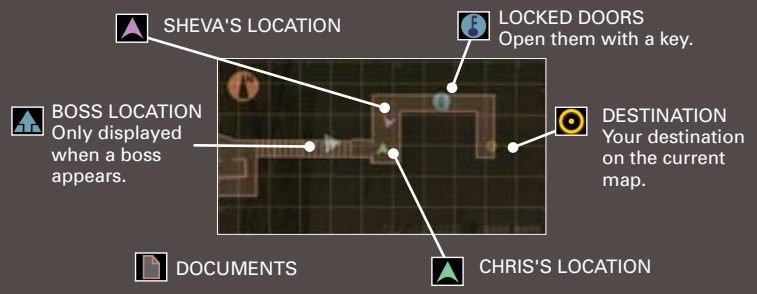

SHEVA'S LOCATION

LOCKED DOORS
Open them with a key.

BOSS LOCATION
Only displayed when a boss appears.

DESTINATION
Your destination on the current map.

DOCUMENTS

CHRIS'S LOCATION

ITEM MANAGEMENT

Here you can choose, buy, sell, or upgrade the items you will carry with you in the game. You can open the ITEM MANAGEMENT screen either by selecting the option from the PLAY GAME screen, or when you select a chapter, continue, or restart.



Here you can trade, move, sell, or combine items. **X** BUTTON move items.

ITEM STOCKPILE

This consists of items that you have acquired during gameplay.

Use the **Y**/**X** Buttons to swap the display between regular items and treasures.

SPECIAL CONTROLS

LB BUTTON: Sell an item

RB BUTTON: Upgrade an item.

COMBINING ITEMS

Combine items to increase their effects and open up space in your Item Menu. Items can also be combined using the in-game item menus.

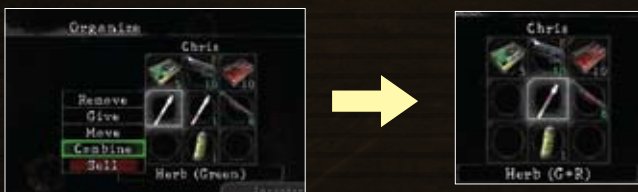

Select the herb that you would like to combine and choose the COMBINE option. Then select the herb with which you would like to combine it with and press the **A** button.

PURCHASING WEAPONS/ITEMS

Use money that you have acquired in the game to purchase new weapons and items. Things purchased here will appear in your item stockpile.

TOTAL MONEY

WEAPON STATS

GOODS AVAILABLE



SELECTED ITEM

IMAGE OF ITEM

PRICE

ABOUT XBOX LIVE

Xbox LIVE is an online gaming environment that lets you connect and play with friends from around the world whenever you want*.

In the Xbox LIVE universe, making friends is as easy as giving someone your Gamercard – it's like having your own personalized business card. Once you've exchanged Gamercards, not only can you play games together, you can also do things like voice chat and send video messages to one another*.

What's more, the Xbox LIVE marketplace offers a wide variety of downloadable content to make your experience even more fun and exciting*.
*Xbox LIVE compatibility varies by game.

USING XBOX LIVE

In order to use Xbox LIVE, you'll have to connect your Xbox 360 to a broadband environment and sign up for Xbox LIVE Service. For more details about the service and connecting your Xbox 360 to a broadband environment, please visit <http://www.xbox.com>.

ADSL Modem/Cable Modem

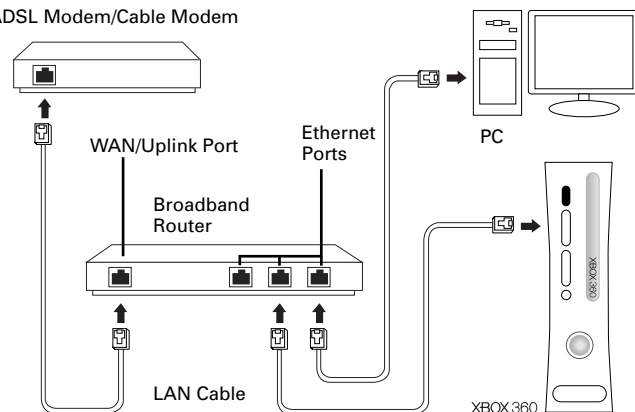

FAMILY SETTINGS

With Family Settings, parents and guardians can quickly and easily regulate their children's access to any of Xbox LIVE's features, as well as to games based on their ESRB Rating.

For more details, please visit <http://www.xbox.com/familysettings>.

HINTS FOR ATTACKING

- Target your enemies' legs or head to make them stumble and easier to kill.
- When you have thrown an enemy off balance, you will have a chance to use an attack action. This will throw the surrounding enemies off balance as well, giving you an opening.



DON'T LEAVE YOUR PARTNER!

If you leave your partner in the midst of battle, chances are that he/she won't be able to save you quickly enough. Try and stay as close as you can, particularly in the heat of combat.

KEEP TRACK OF YOUR PARTNER

Press the **[M]** Button when your partner needs HELP to confirm his/her position. If you press the **[D]** Button and equip a weapon while holding **[M]**, you will automatically aim towards your partner. Be sure to always HELP your partner as quickly as possible.



HOLD DOWN THE [RT] BUTTON AND READY YOUR WEAPON WITH THE [LT] BUTTON!

Press the **[B]** Button during gameplay to say a variety of context-sensitive phrases. There are more phrases than are introduced below.

THANKS!

Thank your partner when they give you an item.



HELP ME!

Scream for assistance when you're in dire straits.



NICE SHOT!



Compliment your partner on a well-placed headshot.



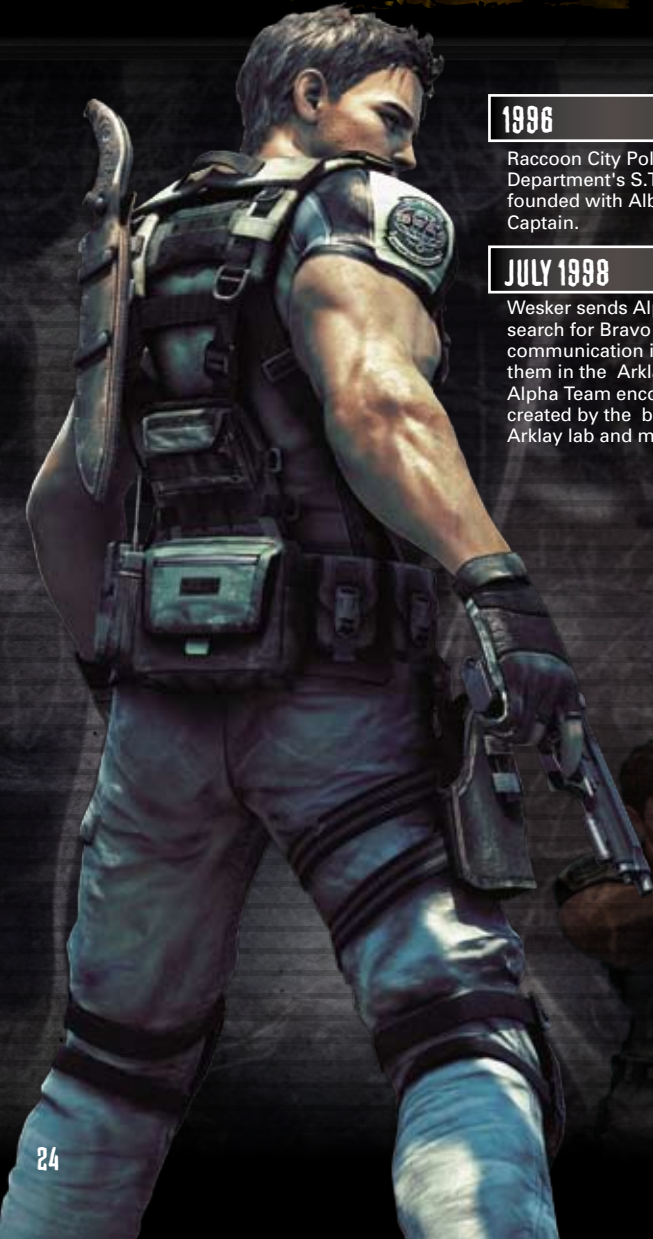

1996

Raccoon City Police Department's S.T.A.R.S. team is founded with Albert Wesker as Captain.

JULY 1998

Wesker sends Alpha Team to search for Bravo Team after communication is lost with them in the Arklay Mountains. Alpha Team encounters zombies created by the biohazard in the Arklay lab and mansion.

Wesker's plans are exposed. After his death at the hands of the Tyrant, an unknown virus within his system revives him. He then gathers B.O.W. materials and escapes the Arklay lab before it is destroyed. Wesker exploits his apparent death to go into hiding.

Former S.T.A.R.S. member Chris Redfield learns of the G-Virus and heads to Europe to investigate Umbrella.

SEPTEMBER 1998

Former S.T.A.R.S. member Jill Valentine infiltrates Raccoon City.

Umbrella deploys the B.O.W. Nemesis T-Type into the city, and it begins its hunt for former S.T.A.R.S. member Jill Valentine. Jill defeats the Nemesis T-Type and escapes with the help of Barry Burton.

OCTOBER 1998

The U.S. government decides to implement a "containment strategy". The president orders a missile attack on Raccoon City, destroying all traces of it.

DECEMBER 1998

Claire infiltrates the Paris laboratory, only to be captured and imprisoned on Rockfort Island.

In order to obtain a sample of the T-Veronica virus, Wesker attacks Rockfort Island with his own private military force and releases the T-Virus onto the island.

Continuing his search for his sister Claire, Chris arrives at Rockfort Island and finds Wesker.

Claire and Chris are reunited at the Antarctic Base, and together they defeat Alexia. They escape in a Harrier jet before the base is destroyed.

2002

Chris and Jill take part in the mission to destroy the Umbrella Caucasus Research Facility in Russia. They were successful in destroying a new B.O.W. known as T-A.L.O.S.

2009

Chris Redfield, now a member of the BSAA, heads to Africa on an investigative mission...

RISE UP...

DARKVOID™



COMING 2009

RATING PENDING
RP
MAY CONTAIN CONTENT
INAPPROPRIATE FOR CHILDREN.
VISIT WWW.ESRB.ORG FOR
RATING INFORMATION.



XBOX 360

XBOX LIVE

CAPCOM®

LOG ON...

CAPCOM-UNITY.COM

TALK TO US! In addition to fan-to-fan discussions, Capcom staffers and even executives read and respond directly to your questions!

Find other fans, competitors, or even **PLAY** against Capcom staff!

EARN REWARDS for community participation and gaming achievements!

Enter Capcom Unity member-only **SWEEPSTAKES AND CONTESTS!**

Check out **BEHIND-THE-SCENES** blogs, articles, and media!

Get **BREAKING NEWS** announcements and **SPECIAL OFFERS** from the Capcom Store!



CAPCOM®

doubledstatue
Rameez Yousefi
THIA & PU Community
Sean [STARS]TyranT'
Hall
Rob McGregor
(ResidentEvilFan.com)
Justin Paul Celani
Richard E. Jimenez
Oen Shvaikov
"ResidentEvilForever.ru"
Ra1DeN
Paul S. Lee
Murillo Gerardo
GamerLimit
Ekamp
Zuko
Rising85
Andreas Gornikewicz
Saner
patriots321
William Matthew Yi
"GuardianE"
Joystiq
ElusionM
Jordan Devore
HUNK59 biohazardfrance
ultimatechance
MisterDevil
lobo_solitario
ps3-talk.de
DirtyDale
Pepito
Jesper Ravn Thuesen
badflame101
David Carillet
Dave "Megatron Wolf"
Schreiber
Chris-Rickfield
Vincent Jablonowski
Leonesaurus
BASSA Jimmy
Hypercoyote
Mark A. Stewart
Josh Edwards

Monique Alves Lourenço
nosferatu101
Antonio "DEATHMARINE"
Falcon
Yoke
Nelson Alejandro Morales
Torres "Nelson TsX"
ffboi7
Reno
Caesar Rivera Jr
Ultimate_Bio-weapon
jrod69
Paineszankio
Cheba
nightie
Roukan
Kangaxx
silverkiller
DarkReaper9
Stephen Spenser Wilson
Alex Charette
rodrigowar
Luis Enrique Palma
Dominguez
alexander37_seahawks
CallToArms182
Sebastian "B4-Hunter"
Michalski
Diego Antonio Rivera
Villavicencio
vegaman-x
wizard200
LeechCharmer
David Lee Corral
goku.
Jordan Krueger
Lauferon Cedric
ShevaxAlomar
NinjaGaijin
Alejandro Hernandez
Ortega
ZombieOverlord
JimmySheen
Link-GS
Michelle Shiroma

Cedric Thievnet
Lvl.3
Anakenobi
sean2173
ItchyTasty06
EvilRyu1986
DyceGamez
jdj
Garner Duff-Harris
Viallon Florent
Devil_89
Loomis
Elisa Taskinen
bbuck
Timothy "sourpk" Russell
SynysterKill92
Erick David Soto Cota
Karty55
Alexandre Audi
"Spartan1590"
Marion C. Alor
flipislander13
tk1989
bluntcorpse
ConsoleGaming
Ezraeille
Crizalid
Sandhand02
IvAncAdU
chevalierzeus

CAPCOM ENTERTAINMENT, INC.

**PRODUCT
DEVELOPMENT
VICE PRESIDENT**
PRODUCT Development
Scot Bayless

Director of Production
Adam Boyes

Product Development Staff

Kraig Kujawa
Gary Lake
Jay Dee Alley
Dave Witcher
William Rompf
Daryl Allison
Shana Bryant
Morgan Gray
Tim Innes
Rey Jimenez
Takashi Kubozono
Justin Lambros
Sean Mountain
Shuheji Yamamoto
Greg Lewickyj
Derek Neal
Robby Zinchak
Darryl Shaw

Directors Brand Marketing

Emily Anadu
Mike Webster

**Senior Product
Marketing Manager**
Grant Luke

Product Marketing
Matt Dahlgren
Frank Filice
John Diamonon
Colin Ferris

Creative Services
Francis Mao
Lindsay Young
Christine Converse
Kevin Converse
Derek Van Dyke
Stacie Yamaki
Tom James
Mark Holtz
Sissie Chang

Manual Production
George Hu
Offbase Productions

Public Relations
Chris Kramer
Melody Pfeiffer
Tim Ng
Jason Allen

Customer Service
Darin Johnston
Randy Reyes

Community
Seth Killian
Shawn Baxter
www.Capcom-Unity.com

Channel Marketing
Josh Margulies
Reed Baird

Operations
Louie Reyes
John Abinsay

**Divisional
Communications**
Kaori Tsukuda
Shino Imao

Localization
Eric Bailey
Miguel Corti
Brandon Gay

**BUSINESS
DEVELOPMENT
AND STRATEGIC
PLANNING**
Strategy Ninjas
Seon King
Christian Svensson
Dean Borgus

Legal
Estela Lemus
Toshi Hosaka

Licensing
Germaine Gioia
Junta Saito
Josh Austin
Amelia Denegre

Special Thanks
Hiroshi Tobisawa
Mark Beaumont
Kazuo Kano
Romanus Wong
Our Friends & Family

CAPCOM®

CAPCOM-UNITY.COM

REGISTER FOR EXCLUSIVE OFFERS & NEWS

REG.CAPCOM.COM